

## ANALYSIS OF PRESTRESSED MECHANISMS

S. PELLEGRINO

Cambridge University Engineering Department, Trumpington Street,  
Cambridge CB2 1PZ, U.K.

(Received 27 May 1989; in revised form 24 October 1989)

**Abstract**—A new theory is presented for the matrix analysis of prestressed structural mechanisms made from pin-jointed bars. The response of a prestressed mechanism to any external action is decomposed into two almost separate parts, which correspond to extensional and inextensional modes. A matrix algorithm which treats these two modes separately is developed and tested. It is shown that the equilibrium requirements for the assembly, in its initial configuration as well as in deformed configurations which are obtained through infinitesimal inextensional displacements, can be fully described by a *square equilibrium matrix*. It is also shown that any set of extensional nodal displacements has to satisfy some equilibrium conditions as well as standard compatibility equations, and that the resulting system of linear equations defines a *square kinematic matrix*. Theoretical as well as experimental evidence supporting this approach is given in the paper; two simple experiments which were of crucial importance in arriving at the equilibrium conditions on the extensional displacements are described.

The interaction between the two modes of action of a prestressed mechanism is discussed, together with a rapidly converging iterative procedure to handle it. A study of the non-linear effect by which the self-stress level in a statically indeterminate assembly rapidly increases if an inextensional mode is excited, supported by further experimental results, concludes the paper. This work is relevant to the analysis of most cable systems, pneumatic domes, fabric roofs, and "Tensegrity" frameworks.

### NOMENCLATURE

(dimensions of vectors and matrices shown in parentheses)

<b>A</b>	standard equilibrium matrix ( $3j-c \times b$ )
<b>A'</b>	modified equilibrium matrix ( $3j-c \times 3j-c$ ), $A' = A' G$
<b>b</b>	total number of bars
<b>B</b>	standard compatibility matrix ( $b \times 3j-c$ )
<b>B'</b>	modified compatibility matrix $B' = (A')^T$
<b>c</b>	total number of kinematic constraints
<b>d</b>	vector of nodal displacements ( $3j-c$ )
<b>D</b>	matrix of inextensional mechanisms ( $3j-c \times m$ )
<b>d'</b>	inextensional mechanism no. $i$ ( $3j-c$ )
<b>e</b>	vector of bar elongations ( $b$ )
<b>g</b>	vector of imposed bar elongations, due to lack-of-fit, etc. ( $b$ )
<b>F</b>	matrix of bar flexibilities ( $b \times b$ )
<b>G</b>	matrix of geometric loads ( $3j-c \times m$ )
<b>j</b>	total number of joints
<b>l</b>	vector of nodal loads ( $3j-c$ )
$L_i$	length of bar $i$
<b>m</b>	number of inextensional mechanisms
<b>r</b>	rank of equilibrium matrix
<b>s</b>	number of independent states of self-stress
<b>ss</b>	self-stress vector ( $b$ )
<b>SS</b>	self-stress matrix ( $b \times s$ )
<b>t</b>	vector of bar axial forces ( $b$ )
$x_i, y_i, z_i$	Cartesian coordinates of joint $i$
<b><math>\alpha</math></b>	vector of $s$ real numbers ( $s$ )
<b><math>\beta, \gamma</math></b>	vectors of $m$ real numbers ( $m$ )

( )<sub>0</sub> indicates an *initial or reference state*, while  $\delta( )$  denotes the *difference between a final and an initial state*; ( )<sub>Y</sub> denotes a vector or a matrix of a *reduced size*, obtained by removing all elements which correspond to redundant bars; ( )<sup>(i)</sup> and ( )<sup>(ii)</sup> denote *mode (i) and mode (ii) response*, respectively; and ( )<sup>c</sup> denotes a *corrective vector*.

### 1. INTRODUCTION

Prestressed mechanisms are becoming increasingly popular in structural engineering. The most commonly used types include cable systems (i.e. single hanging cables and cable nets), pneumatic domes, fabric roofs, and "Tensegrity" frameworks, all of which rely on prestress

to achieve stiffness, and also to prevent any cable segments or fabric panels from becoming slack.

The structural analysis techniques employed for normal structures break down when applied to mechanisms, and therefore it is common practice to resort to geometrically non-linear iterative schemes for the above structures, as described by Mollmann (1974) and Buchholdt (1985). However, this kind of approach does not provide much insight: the deflections due to any load condition, or the effects of a design change, can be computed to a high accuracy, but no rough estimates can be made. Paradoxically, though, the deflections one computes are often small, in the sense of a conventional small-displacement theory, and hence a full-powered non-linear approach seems unjustified.

This paper, pursuing an approach initiated by Calladine (1982) and Pellegrino and Calladine (1984), sets up a new theory for the analysis of kinematically indeterminate prestressed assemblies, based upon an essentially linear approach which captures the main features of their behaviour. Throughout the paper, we shall deal with three-dimensional assemblies whose  $j$  joints are connected by  $b$  pin-jointed bars; a total number of  $c$  kinematic constraints prevent the joints from moving in certain directions. Each bar can resist both tensile and compressive axial forces, and its deformation follows a linear-elastic law. Cable segments are not ruled out: in the hypothesis that a suitable state of pretension prevents them from becoming slack, we shall assume that they can be treated as bars for the sake of the analysis. We shall also briefly consider the possibility of cable slackening.

A crucial, initial step is that of introducing the structural variables which are required for our study.

### 1.1. Static variables

The  $x$ -,  $y$ -, and  $z$ -components of the external forces applied at each node of the assembly, in an unconstrained direction, are assembled in the  $(3j - c)$ -dimensional *nodal loads vectors*  $\mathbf{l}$ . The  $b$  axial forces are assembled in the *tension vector*  $\mathbf{t}$ , with the convention that  $t_i$  (axial force in bar  $i$ ) is positive if tensile. (For statically indeterminate assemblies, which will be formally introduced later in this section, it is convenient to introduce also the vector  $\mathbf{t}'$ , which contains a reduced number of axial forces.)

### 1.2. Kinematic variables

The  $x$ -,  $y$ -, and  $z$ -components of the displacement of each node of the assembly, excluding (as for  $\mathbf{l}$ ) kinematically constrained directions, are assembled in the  $(3j - c)$ -dimensional *nodal displacements vector*  $\mathbf{d}$ . The  $b$  bar elongations are assembled to form the *elongation vector*  $\mathbf{e}$ , in which a positive  $i$ th component  $e_i$  (elongation of bar  $i$ ) denotes an increase of length. (For statically indeterminate assemblies, a reduced elongation vector  $\mathbf{e}'$  will also be considered.)

Until further notice we shall operate within the context of a conventional small-deflection theory; in particular, any type of instability, e.g. snap-through, is ruled out. Therefore the following relationships between the four sets of structural variables are satisfied.

### 1.3. Equilibrium

The static variables  $\mathbf{l}$  and  $\mathbf{t}$  have to satisfy a set of linear equilibrium equations, which are usually written in the form

$$\mathbf{A} \mathbf{t} = \mathbf{l} \quad (1)$$

The  $(3j - c \times b)$  coefficient matrix  $\mathbf{A}$  is the *equilibrium matrix* of the assembly. In setting up the system (1) we consider three equilibrium equations for any unconstrained joint, but we consider a reduced number of equations for those pin-joints which are held by kinematic constraints to a rigid boundary. Details can be found in Livesley (1975) and Pellegrino and Calladine (1986).

1.4. *Compatibility*

The kinematic variables  $\mathbf{d}$  and  $\mathbf{e}$  have to satisfy a set of linear compatibility equations

$$\mathbf{B} \mathbf{d} = \mathbf{e}. \tag{2}$$

The  $(b \times 3j - c)$  coefficient matrix  $\mathbf{B}$  is the *compatibility matrix* of the assembly.  $\mathbf{B}$  can be obtained from considerations of compatibility of deformation for each bar of the assembly, or directly from the equilibrium matrix, since  $\mathbf{B} = \mathbf{A}^T$  (Livesley, 1975).

1.5. *Material behaviour*

The elongation  $e_i$  consists of an initial, or inelastic, part  $e_i$  due to thermal strains, lack of fit, etc., and of a linear-elastic part  $f_i t_i$ . Here the *axial flexibility*  $f_i$  of bar  $i$  depends on its length  $L_i$ , cross-sectional area  $A_i$  and Young's modulus  $E_i$ :  $f_i = L_i/A_i E_i$ . Thus, the total elongation of bar  $i$  is  $e_i = e_i + f_i t_i$ , and therefore the vectors  $\mathbf{e}$  and  $\mathbf{t}$  are related by

$$\mathbf{e} = \mathbf{g} + \mathbf{F} \mathbf{t}. \tag{3}$$

The  $b$ -dimensional diagonal matrix  $\mathbf{F}$  has  $f_i$  as its entry of position  $(i, i)$ .

1.6. *Classification*

We shall begin by discussing under which conditions the systems (1) and (2) admit at least one solution, and whether or not their solutions are unique. This approach was first proposed by De Veubeke (1973). Following Pellegrino and Calladine (1986), we consider the matrix  $\mathbf{A}$  as a linear operator between two vector spaces: the *bar space*  $\mathcal{R}^b$  and the *joint space*  $\mathcal{R}^{3j-c}$ . The four fundamental subspaces associated with  $\mathbf{A}$ , which in fact coincide with the subspaces associated with the compatibility matrix  $\mathbf{B} (= \mathbf{A}^T)$ , are shown in Fig. 1. Note that the dimensions of the four subspaces can be easily computed once the *rank*  $r$  of the equilibrium matrix is known. Pellegrino and Calladine (1986) show a possible way of computing a basis for each of the four subspaces.

The conditions for existence and uniqueness of a solution to the systems (1) and (2) can be derived from the following four cases.

If the Left-nullspace of  $\mathbf{A}$  has dimension  $m = 0$ , any load  $\mathbf{l}$  can be equilibrated by the assembly in its initial configuration; therefore (1) admits at least one solution for any  $\mathbf{l}$ .

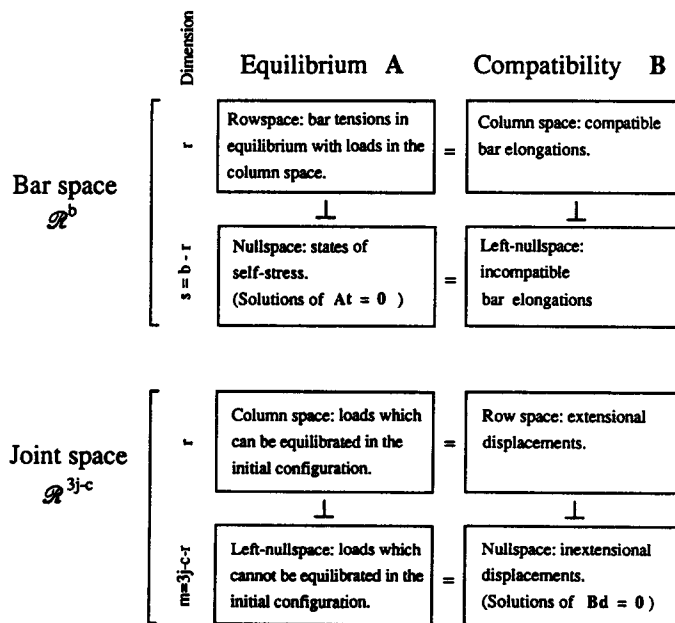

Fig. 1. The four fundamental subspaces associated with the equilibrium matrix  $\mathbf{A}$  and the compatibility matrix  $\mathbf{B} (= \mathbf{A}^T)$ . A simple algorithm to compute a basis for each of the four subspaces has been described by Pellegrino and Calladine (1986). The sign "=" indicates that two subspaces coincide, while "⊥" indicates that they are orthogonal complements of one another.

Because the Left-nullspace of  $\mathbf{A}$  coincides with the Nullspace of  $\mathbf{B}$ , any set of nodal displacements  $\mathbf{d}$  is extensional, and therefore associated with a unique set of compatible elongations; this implies that (2) admits at most one solution. Assemblies with  $m = 0$  are known as *kinematically determinate*.

If  $m > 0$  the assembly is *kinematically indeterminate*, and  $m$  is the number of independent inextensional mechanisms. The system (1) can be solved only for loads  $\mathbf{l}$  which lie in the Column space of  $\mathbf{A}$ , otherwise it admits no solution. The solution of (2), for any set of compatible elongations  $\mathbf{e}$ , is not unique.

If the Nullspace of  $\mathbf{A}$  has dimension  $s = 0$ , the assembly admits no sets of self-equilibrated tensions; it is therefore *statically determinate*. The system (1) has at most one solution for any loads  $\mathbf{l}$  in the Column space of  $\mathbf{A}$ . Because the Nullspace of  $\mathbf{A}$  coincides with the Left-nullspace of  $\mathbf{B}$ , all sets of bar elongations are compatible; therefore (2) admits at least one solution for any  $\mathbf{e}$ .

If  $s > 0$  the assembly is *statically indeterminate*, and  $s$  is the number of independent states of self-stress it admits. The solution of (1) is not unique for any  $\mathbf{l}$  in the Column space of  $\mathbf{A}$ . The system (2) can be solved only for elongations  $\mathbf{e}$  which lie in the Column space of  $\mathbf{B}$ , otherwise it has no solution.

From the foregoing discussion, we expect that the analysis of a given structural assembly poses different problems depending on whether the assembly is kinematically determinate or indeterminate, and whether statically determinate or indeterminate. A preliminary step is the introduction of the four types of structural assemblies set out in Table 1. Examples of each type of assembly are encountered in structural engineering: types I and III include the more common braced frameworks used for reticulated domes, electrical transmission towers, etc.; typical examples of type II and type IV assemblies are the hanging cables shown in Figs 3 and 4 and the cable net of Fig. 6, respectively. "Tensegrity" systems, discussed by Fuller (1975), Calladine (1978) and Hanaor (1987), are also of type IV.

The analysis of type I assemblies poses no difficulty, because both the system of equilibrium equations and that of compatibility equations have square coefficient matrices of full rank. Given a set of loads  $\mathbf{l}$  and imposed elongations  $\mathbf{e}$ , one can solve (1) for the tensions  $\mathbf{t}$ , then obtain the elongations  $\mathbf{e}$  from (3), and finally solve (2) for the displacements  $\mathbf{d}$ . All other types involve one or more departures from this straightforward route, and are discussed in the following sections.

The layout of the paper is as follows. In Section 2, primarily concerned with assemblies of type III, we determine a unique set of bar tensions among an  $s$ -dimensional infinity which are all in equilibrium with an applied load. In Sections 3 and 4 we extend the analysis to prestressed assemblies of types II and IV; we introduce *square* modified equilibrium and

Table 1. Four different types of structural assemblies

Assembly type	Dimensions of Nullspace and Left-nullspace	Static and kinematic features
I Statically determinate and kinematically determinate	$s = 0$ $m = 0$	Both (1) and (2) have a unique solution for any r.h.s.
II Statically determinate and kinematically indeterminate	$s = 0$ $m > 0$	(1) has a unique solution for some particular r.h.s., but otherwise no solution. (2) has an infinite number of solutions for any r.h.s.
III Statically indeterminate and kinematically determinate	$s > 0$ $m = 0$	(1) has an infinite number of solutions for any r.h.s. (2) has a unique solution for some particular r.h.s., but otherwise no solution
IV Statically indeterminate and kinematically indeterminate	$s > 0$ $m > 0$	Both (1) and (2) have an infinite number of solutions for some particular r.h.s., but otherwise no solution

The structural response of all four types is analysed in this paper: types I and III in Sections 1 and 2, and types II and IV in Sections 3-5.

compatibility matrices, from which we can make *linear predictions* of response. In Section 5 we discuss the *stiffening response* of type IV assemblies and, for the most common type ( $s = 1$ ), we introduce a non-linear correction based on the solution of a single cubic equation. In Section 6, we compare our predictions with experimental measurements taken on a saddle-shaped cable-net. A discussion of the approach proposed in the paper, and of its limitations, and a summary of the analysis method conclude the paper.

2. STATICALLY INDETERMINATE AND KINEMATICALLY DETERMINATE ASSEMBLIES

In this section we compute the response of an assembly with  $s > 0$  and  $m = 0$ , that is an assembly of type III, to a set of nodal loads  $\mathbf{l}$  and imposed elongations  $\mathbf{g}$ . Such an assembly has a rectangular equilibrium matrix, with more columns than rows. The solution  $\mathbf{t}$  of the system of equilibrium equations (1) can be written in the form

$$\mathbf{t} = \mathbf{t}' + \mathbf{SS} \boldsymbol{\alpha}, \tag{4}$$

where  $\mathbf{t}'$  is any set of bar tensions in equilibrium with the applied load  $\mathbf{l}$ ;  $\mathbf{SS}$  contains  $s$  independent states of self-stress, that is a basis of the Nullspace of  $\mathbf{A}$ , arranged by columns;  $\boldsymbol{\alpha}$  is an arbitrary vector of  $s$  real coefficients. It can be readily shown that eqn (4) is a solution of eqn (1) for any  $\boldsymbol{\alpha}$ : simply substitute (4) into (1) and recall that any state of self-stress solves the homogeneous system of equations  $\mathbf{A} \mathbf{t} = \mathbf{0}$ . It can be also shown that all solutions of eqn (1) are obtained from eqn (4), when  $\boldsymbol{\alpha}$  varies in  $\mathcal{R}^s$ .

Several matrix algorithms to compute  $\mathbf{t}'$  and  $\mathbf{SS}$  are available (Strang, 1980; Golub and Van Loan, 1983). The simplest of all, based on Gaussian elimination with partial pivoting, transforms the matrix  $\mathbf{A}$  by row operations into a generalized upper triangular matrix  $\tilde{\mathbf{A}}$  (row echelon form); the same operations transform the vector  $\mathbf{l}$  into  $\tilde{\mathbf{l}}$ . The systems  $\mathbf{A} \mathbf{t} = \mathbf{l}$  and  $\tilde{\mathbf{A}} \mathbf{t} = \tilde{\mathbf{l}}$  admit identical solutions.

It is convenient to operate on the adjoint matrix  $\mathbf{A}|\mathbf{l}$ , which can be transformed by row operations into  $\tilde{\mathbf{A}}|\tilde{\mathbf{l}}$  (see Fig. 2). In Fig. 2, the  $r$  ( $= 5$ ) columns of  $\tilde{\mathbf{A}}$  which contain pivots have been marked \*; the corresponding columns of  $\mathbf{A}$ , also marked \*, form a set of *linearly independent* vectors spanning the Column space of  $\mathbf{A}$ . The  $s$  ( $= 2$ ) columns not marked \* correspond to the *redundant bars* of the assembly.

We shall denote by  $\mathbf{A}'$  the  $(3j - c \times r)$  matrix obtained by deleting from  $\mathbf{A}$  the columns which correspond to the redundant bars.

2.1. Bar tensions  $\mathbf{t}'$  in equilibrium with  $\mathbf{l}$ .

The  $s$  components of  $\mathbf{t}'$  which correspond to redundant bars can be set equal to zero, while the remaining  $r$  components of  $\mathbf{t}'$  are calculated from  $\tilde{\mathbf{A}}|\tilde{\mathbf{l}}$ , through a straightforward back-substitution. The columns of  $\tilde{\mathbf{A}}$  not marked \* do not enter this process, therefore in practice the back-substitution involves only a square upper-triangular matrix. Obviously, the result of this operation is uniquely determined.

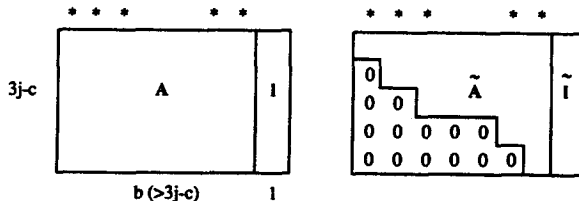

Fig. 2. Transformation of  $\mathbf{A}|\mathbf{l}$  into  $\tilde{\mathbf{A}}|\tilde{\mathbf{l}}$  for an assembly of type III. The rank  $r$  of  $\mathbf{A}$  is equal to the number of columns which contain a pivot; these columns are marked \* in the figure. Note that each row contains a pivot, hence  $r = 3j - c$ ,  $s > 0$  and  $m = 0$ . The same technique can be applied also to assemblies of types II and IV, in which case all entries in the bottom  $m$  rows of  $\mathbf{A}$  vanish. Details on the transformation, numerical strategy, etc. can be found in Pellegrino and Calladine (1986).

## 2.2. States of self-stress $SS$ .

The first state of self-stress has  $t_i = -1$  in the first redundant bar, and  $t_i = 0$  in the other  $(s-1)$  redundant bars. The tensions in the non-redundant bars are then the unique solution of  $\tilde{\mathbf{A}} \mathbf{t} = \mathbf{0}$ , easily obtained by back-substitution. The second state of self-stress has  $t_i = -1$  in the second redundant bar and  $t_i = 0$  in the remaining  $(s-1)$ , and so on. This process generates a set of  $s$  independent states of self-stress for the assembly, which form  $SS$ . There are many other ways of generating a set, usually different, of independent states of self-stress; for instance Gillis and Gerstle (1961), Filho (1966), and Robinson and Haggemacher (1970) have proposed that the criterion for choosing one particular set should be that of achieving optimal numerical conditioning of the matrix  $SS^T F SS$ , while Kaneko *et al.* (1982) and Berry *et al.* (1985) discuss algorithms which minimize the bandwidth of  $SS^T F SS$ . Because in this paper we are not concerned with detailed computational aspects, we have chosen the easiest of all procedures.

Among the  $s$ -dimensional infinity [eqn (4)] of bar tension sets which satisfy the equilibrium equations (1), we choose that particular value of  $\alpha$  which gives geometrically compatible bar elongations. Substitution of eqn (4) into eqn (3) yields

$$\mathbf{e} = \mathbf{e} + \mathbf{F}(\mathbf{t}' + SS \alpha), \quad (5)$$

which expresses the set of bar elongations in terms of  $s$  unknown parameters. Precisely  $s$  conditions are obtained by imposing that the elongations [eqn (5)] be *orthogonal to the subspace of incompatible elongations* (Left-nullspace of  $\mathbf{B}$ ). Recalling (Fig. 1) that the Left-nullspace of  $\mathbf{B}$  is spanned by  $s$  independent states of self-stress, the orthogonality condition can be written in the form

$$SS^T \mathbf{e} = \mathbf{0}, \quad (6)$$

from which, substituting eqn (5) and tidying up

$$SS^T F SS \alpha = -SS^T (\mathbf{e} + \mathbf{F} \mathbf{t}'), \quad (7)$$

which is indeed a system of  $s$  linear equations in the  $s$  unknowns  $\alpha$ . This system has a unique solution for any r.h.s. because its  $(s \times s)$  coefficient matrix  $SS^T F SS$  is not singular, the  $s$  rows of  $SS^T$  being independent and  $\mathbf{F}$  diagonal (Strang, 1980). Equations equivalent to eqn (7) can be found in textbooks on matrix analysis of structures which cover the Force Method [e.g. Pestel and Leckie (1963) or Livesley (1975)], where they are obtained through a virtual work argument. Similar equations have been used by Robinson (1966), in the development of the Rank Force Method, and Przemieniecki (1968), by minimizing the total energy in the assembly.

After solving eqn (7) for  $\alpha$ , we obtain  $\mathbf{t}$  from eqn (4). To complete the analysis, we evaluate  $\mathbf{e}$  from eqn (3), and then solve eqn (2) for  $\mathbf{d}$ . Because  $\mathbf{e}$  is compatible, the  $s$  rows of  $\mathbf{B}$  corresponding to redundant bars, and also the corresponding elongations in the vector  $\mathbf{e}$ , can be neglected. Thus, we are left with an  $(r \times r)$  square compatibility matrix  $\mathbf{B}'$  and an elongation vector  $\mathbf{e}'$  of size  $r$ . Note that  $\mathbf{B}'$  is the transpose of the matrix  $\mathbf{A}'$  introduced earlier. The system

$$\mathbf{B}' \mathbf{d} = \mathbf{e}' \quad (8)$$

can be solved by any standard method. However, by keeping a record of the row operations which transform  $\mathbf{A}$  into  $\tilde{\mathbf{A}}$ , several computations can be saved.

## 3. BAR TENSIONS AND INEXTENSIONAL DISPLACEMENTS OF KINEMATICALLY INDETERMINATE ASSEMBLIES

Now, let us consider a kinematically indeterminate assembly which is in equilibrium, in the given configuration, under an initial load  $\mathbf{l}_0$  and prestressing bar tensions  $\mathbf{t}_0$ :

$$\mathbf{A} \mathbf{t}_0 = \mathbf{l}_0. \quad (9)$$

If the assembly is statically indeterminate as well, some imposed bar elongations  $\mathbf{g}$  (obtained by altering the length of one or more bars) may be the cause of  $\mathbf{t}_0$ ; in this case  $\mathbf{l}_0$  could be zero. We shall assume that the prestressed assembly is in *stable equilibrium* in its initial configuration, and hence that a positive first-order stiffness will resist any inextensional deformation.

Our aim in this section is to compute the change of bar tensions  $\delta \mathbf{t}$  which is caused by an additional load  $\delta \mathbf{l}$  and additional imposed elongations  $\delta \mathbf{g}$ . As noted in Section 1, the system (1) of equilibrium equations will admit no solution if  $\delta \mathbf{l}$  has a non-vanishing component in the Left-nullspace of  $\mathbf{A}$ . However, our assembly has two distinct ways of equilibrating an additional load  $\delta \mathbf{l}$ : it can (i) *alter its bar tensions* by  $\delta \mathbf{t}$  and hence carry the load with little displacement from its initial configuration, and indeed the system of equations (1) accounts for this type of behaviour only; or (ii) *deform inextensionally* at approximately constant stress, in which case the load is equilibrated by out-of-balance forces arising from the change of geometry (Kuznetsov, 1973; Calladine, 1982; Pellegrino and Calladine, 1984, 1986). In many instances the assembly responds by a combination of modes (i) and (ii); we shall analyse this combined response after investigating each mode separately.

For the sake of generality, we shall refer explicitly to statically indeterminate and kinematically indeterminate assemblies (type IV). We shall assume that some preliminary computations have been performed to obtain  $m$  independent inextensional mechanisms  $\mathbf{d}^1, \mathbf{d}^2, \dots, \mathbf{d}^m$ , forming the  $(3j-c \times m)$  matrix  $\mathbf{D}$ , and  $s$  independent states of self-stress, forming the matrix  $\mathbf{SS}$ . A possible way of obtaining  $\mathbf{D}$  and  $\mathbf{SS}$ , which is fully described by Pellegrino and Calladine (1986), involves the transformation of the adjoint matrix  $\mathbf{A}|\mathbf{I}$ , where  $\mathbf{I}$  is a  $(3j-c \times 3j-c)$  identity matrix, into  $\tilde{\mathbf{A}}|\tilde{\mathbf{I}}$  by row operations similar to those in Section 2. From  $\tilde{\mathbf{A}}$ , we can determine the rank  $r$  of  $\mathbf{A}$  and also, if  $s > 0$ ,  $s$  independent states of self-stress forming the matrix  $\mathbf{SS}$ , as in Section 2. This calculation also identifies a set of  $s$  redundant bars, and hence the  $(3j-c \times r)$  matrix  $\mathbf{A}'$ . The bottom  $m$  rows of  $\tilde{\mathbf{I}}$ , which correspond to rows of  $\tilde{\mathbf{A}}$  without pivots, provide us with a set of independent inextensional mechanisms, from which we form  $\mathbf{D}$ .

### 3.1. Mode (i)

Recall (Fig. 1) that the Column space of  $\mathbf{A}$  contains all of the loads which can be equilibrated in the initial configuration; we shall denote such loads by  $\delta \mathbf{l}^{(i)}$ . Because the  $s$  redundant bars provide no additional ability to carry loads, the full system of equilibrium equations (1) can be replaced with

$$\mathbf{A}' \delta \mathbf{t}' = \delta \mathbf{l}^{(i)}, \quad (10)$$

where  $\mathbf{A}'$  is the  $(3j-c \times r)$  matrix defined in Section 2;  $\delta \mathbf{t}'$  contains the changes of axial forces in the  $r$  non-redundant bars. The system (10) is, of course, the complete system of equilibrium equations for the statically determinate assembly obtained by removing the  $s$  redundant bars from the original assembly.

Given a load  $\delta \mathbf{l}^{(i)}$ , eqn (10) admits a unique solution. We can find  $\delta \mathbf{t}'$ , in analogy with Section 2, by transforming  $\mathbf{A}'|\delta \mathbf{l}^{(i)}$  into  $\tilde{\mathbf{A}}'|\delta \tilde{\mathbf{l}}^{(i)}$ :  $\delta \mathbf{t}'$  is given by the top  $r$  entries of  $\delta \tilde{\mathbf{l}}^{(i)}$ . The remaining  $m$  entries of  $\delta \tilde{\mathbf{l}}^{(i)}$  will vanish; indeed, a non-vanishing entry in the lower part of this vector would show that  $\delta \mathbf{l}^{(i)}$  does not lie in the Column space of  $\mathbf{A}$ . Because the original assembly has  $s$  redundant bars as well, we form a  $b$ -dimensional vector  $\delta \mathbf{t}'$  by interspersing  $s$  zeros (each corresponding to one of the redundant bars) among the  $r$  entries of  $\delta \mathbf{t}'$ . Note that the bar tensions  $\delta \mathbf{t}'$  are in equilibrium with  $\delta \mathbf{l}^{(i)}$ . To complete the calculation, we consider the general solution of the system of equilibrium equations  $\delta \mathbf{t} = \delta \mathbf{t}' + \mathbf{SS} \boldsymbol{\alpha}$  and compute  $\boldsymbol{\alpha}$  from the compatibility equations

$$\mathbf{SS}^T \mathbf{F} \mathbf{SS} \boldsymbol{\alpha} = -\mathbf{SS}^T (\delta \mathbf{g} + \mathbf{F} \delta \mathbf{t}').$$

For statically determinate assemblies ( $s = 0$ )  $\mathbf{A} = \mathbf{A}^r$  and  $\delta \mathbf{t} = \delta \mathbf{t}^r$ , and therefore these additional computations are not required.

The prestressing tensions  $t_0$  due to the initial load  $\mathbf{l}_0$  (which must lie in the Column space of  $\mathbf{A}$ ) and to the imposed elongations  $\mathbf{e}$ , could be computed following precisely this method. In practice, though, this computation can become part of the initial transformation of  $\mathbf{A}|\mathbf{l}_0$  into  $\tilde{\mathbf{A}}|\tilde{\mathbf{l}}$ , if  $\mathbf{l}_0$  is known at the outset. An example is shown in Section 4.

### 3.2. Mode (ii)

Any infinitesimal inextensional displacement from the original configuration, while leaving (to the first order) the prestress unchanged, results in unbalanced loads of magnitude proportional to the size of the displacement. A general inextensional displacement  $\mathbf{d}^{(ii)}$  is given by

$$\mathbf{D}\boldsymbol{\beta} = \mathbf{d}^{(ii)}, \quad (11)$$

where  $\mathbf{D}$  is the  $(3j - c \times m)$  matrix of inextensional mechanisms defined above;  $\boldsymbol{\beta}$  contains the  $m$  participation coefficients of these mechanisms.

The out-of-balance forces associated with  $\mathbf{d}^{(ii)}$  are

$$\mathbf{G}\boldsymbol{\beta} = \delta \mathbf{l}^{(ii)}, \quad (12)$$

where each column of the  $(3j - c \times m)$  matrix  $\mathbf{G}$  represents the *geometric loads* or “*product forces*” (Pellegrino and Calladine, 1984, 1986), associated with an inextensional mechanism.

The geometric loads in eqn (12) are obtained from the following considerations. Let joint  $i$  be an unconstrained joint of the assembly, connected by bar  $k$  to joint  $j$ . The equilibrium equation in the  $x$ -direction of joint  $i$ , with the assembly in its initial prestressed configuration, is

$$\sum_k \frac{x_i - x_j}{L_k} t_{0k} = l_{0ix} \quad (13)$$

where  $x_i$  is the  $x$ -coordinate of joint  $i$ ,  $L_k$  is the length of bar  $k$ ,  $t_{0k}$  is the prestressing force in bar  $k$ , and  $l_{0ix}$  is the  $x$ -component of the initial load  $\mathbf{l}_0$  on joint  $i$ . The summation in eqn (13) is extended to all bars connected to joint  $i$ . Equation (13) coincides with one of the equations in system (9). We then consider the equilibrium equation in the  $x$ -direction of joint  $i$ , with the assembly in an infinitesimally displaced configuration obtained by imparting the inextensional displacement  $\mathbf{d}^h \boldsymbol{\beta}_h$ , where  $\boldsymbol{\beta}_h$  is sufficiently small. Assuming that all bar tensions are unchanged from  $t_0$ , the new equilibrium equation is obtained simply by replacing the initial joint coordinates in eqn (13) with their updated values; hence  $x_i$  becomes  $(x_i + d_{ix}^h \beta_h)$ , and similarly  $x_j$  becomes  $(x_j + d_{jx}^h \beta_h)$ . All bar lengths remain unchanged because the imposed displacement is inextensional. An additional force  $\delta l_{ix}^h$  is required on the r.h.s. to satisfy equilibrium. Thus, the updated version of eqn (13) is

$$\sum_k \frac{(x_i + d_{ix}^h \beta_h) - (x_j + d_{jx}^h \beta_h)}{L_k} t_{0k} = l_{0ix} + \delta l_{ix}^h. \quad (14)$$

Subtracting eqn (13) from eqn (14) we obtain

$$\left( \sum_k \frac{d_{ix}^h - d_{jx}^h}{L_k} t_{0k} \right) \beta_h = \delta l_{ix}^h. \quad (15)$$

The summation in parentheses gives the  $x$ -component of the geometric load at joint  $i$  associated with a unit amplitude of mechanism  $h$ , hence one of the coefficients in column



$h$  of  $G$ . Similar expressions are valid in the  $y$ - and  $z$ -directions. It is noteworthy that the term in brackets in eqn (15) can be obtained formally from eqn (13), simply by replacing each nodal coordinate with the corresponding component of inextensional displacement.

A kinematically indeterminate assembly in which the *axial forces remain constant* at the level  $t_0$  would be able to equilibrate any load increments which lie in the Column space of the matrix  $G$ , simply by distorting in an inextensional mode. For any such loads, the system of linear equations (12) admits at least one solution. In fact  $G$  has full rank for most prestressed assemblies used in practice, and therefore the solution  $\beta$  of eqn (12) is unique. Once  $\beta$  is known, the displacements due to  $\delta l^{(ii)}$  are obtained from eqn (11).

### 3.3. Combined response in modes (i) and (ii)

Now we can analyse the response of a prestressed kinematically indeterminate assembly to a *general load increment*  $\delta l$ . Since the load is resisted by the combined action of modes (i) and (ii), we consider the sum of eqns (10) and (12)

$$A' \delta t' + G \beta = \delta l^{(i)} + \delta l^{(ii)}.$$

The r.h.s. of this system is precisely  $\delta l$  because our hypothesis, that the assembly is in stable equilibrium in its initial configuration, and hence that the quadratic form  $\beta^T G^T D \beta$  is positive definite (Calladine and Pellegrino, 1990), implies that the *prestress stiffens all  $m$  inextensional mechanisms*. Hence  $A' | G$  spans the joint space.

The bar tension changes  $\delta t'$  and the displacement coefficients  $\beta$  due to  $\delta l$  can be computed by solving the following system :

$$[A' | G] \begin{bmatrix} \delta t' \\ \beta \end{bmatrix} = \delta l. \quad (16)$$

Here, the coefficient matrix  $A' = A' | G$  is a new *square equilibrium matrix* of size  $(3j - c)$ . These new equilibrium equations are valid not only for the original configuration of the prestressed assembly, but also in all distorted configurations obtainable through inextensional displacements of infinitesimal magnitude.

A further set of  $r$  geometric loads which correspond to the *extensional modes* of the assembly could be easily introduced; indeed, they would coincide with the "imaginary loads" used by Argyris (1964) for the analysis of large-displacement problems by the Force Method. These additional geometric loads would be then simply added to the columns of  $A'$  (Pellegrino, 1986), but their effect on the final solution has been found to be negligible in most cases.

The system (16) can be solved uniquely for the vector  $\delta t' | \beta$ , which contains the mixed set of unknowns of this formulation. Because  $A'$  has full rank, eqn (16) can be solved by any method for the solution of systems of linear equations. However, it is convenient to use Gaussian elimination on  $A' | \delta l$ ; the first  $r$  columns of  $A'$  need not be transformed again, provided that details of the transformation from  $A$  to  $\tilde{A}$  have been stored in a suitable way, (Strang, 1980). Once  $\delta t'$  and  $\beta$  have been computed, the complete solution  $\delta t$  is obtained following the procedure described above with reference to mode (i), while the inextensional component of the nodal displacement is  $d^{(ii)} = D \beta$ .

The validity of eqn (16) rests upon the assumption that the bar tensions remain at the level  $t_0$ , while in fact they become  $t_0 + \delta t$ . If  $\delta t$  is small relative to  $t_0$ , there is no need to refine this analysis. Otherwise the geometric loads  $G$  should be recomputed on the basis of the updated tensions  $t_0 + \delta t$ , and an improved estimate of  $\delta t$  obtained from a modified system (16). This process converges after only a few iterations; typically, up to 10 iterations are required for problems in which the final stress level is approximately double the prestress. So far, in each iteration the matrix  $G$  has been calculated using the tensions computed in the previous iteration, without any attempt to optimise the scheme. This is an obvious area for further work. Some assemblies, e.g. flat grids under arbitrary loads, require at most two iterations because the Column spaces of  $A$  and  $G$  are *disjoint*.

The next task is to compute  $d^{(i)}$ , the extensional component of  $d$ , due to the elongations  $\delta e = \delta e + F \delta t$ .

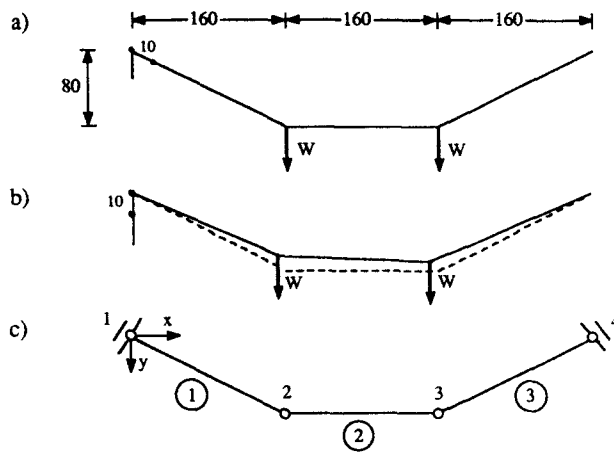

Fig. 3. Schematic description of an experiment to investigate the extensional displacements of a hanging cable under concentrated loads. (a) and (b) show the initial and the deformed configurations, respectively. All dimensions are in mm. The deformation from (a) to (b) is due to the r.h.s. cable segment being shortened by 10 mm. The measured displacements are given in Table 2. (c) shows an equivalent plane pin-jointed assembly, which is analysed in Section 4.

#### 4. EXTENSIONAL DISPLACEMENTS OF KINEMATICALLY INDETERMINATE ASSEMBLIES: AN EXAMPLE

As noted in Section 1, the system (2) of compatibility equations admits more than one solution for any compatible bar elongations  $\delta e$ . Our aim in this section is to identify some additional conditions which determine a unique displacement vector.

In analogy with Section 2, we delete from eqn (2) the compatibility equations which refer to the  $s$  redundant bars to obtain

$$\mathbf{B}' \mathbf{d}^{(i)} = \delta e^r, \quad (17)$$

which is equivalent to eqn (8), but the coefficient matrix  $\mathbf{B}'$  is *rectangular* with fewer rows ( $r$ ) than columns ( $3j - c = m + r$ ). In analogy with eqn (4), we can write

$$\mathbf{d}^{(i)} = \mathbf{d}' + \mathbf{D} \boldsymbol{\gamma}, \quad (18)$$

where  $\mathbf{d}'$  is any set of nodal displacements which are compatible with the elongations  $\delta e^r$ , and hence with  $\delta e$ ; the term  $\mathbf{D} \boldsymbol{\gamma}$  represents a general inextensional displacement which satisfies the homogeneous system  $\mathbf{B} \mathbf{d} = \mathbf{0}$ , and therefore can be freely superposed to  $\mathbf{d}'$  when solving eqn (17). To determine the  $m$  components of  $\boldsymbol{\gamma}$ ,  $m$  additional conditions on  $\mathbf{d}^{(i)}$  must be found.

At this stage it may be useful to describe two simple experiments which provided important clues for the solution of this problem.

In the first experiment (see Fig. 3a), two equal weights were hung by means of short wires from a thin copper wire whose ends were supported by level drawing pins fixed to a vertical board. A sheet of graph paper had previously been stuck on the board, to measure visually both the initial configuration and any displacements from it. The test consisted of measuring the joint deflections caused by a 10-mm shortening of cable segment 1, which was obtained by letting 10 mm of wire slide through the left-hand pin. The lengths of cable segments 2 and 3 were fixed by soldering the joints. The horizontal and vertical components of displacements of these two joints were measured to an accuracy of  $\pm 0.5$  mm, and are given in Table 2.

Table 2. Comparison of measured and computed components of nodal displacement (mm) for the cable shown in Fig. 3

Displacement components	Experiment	Computed (Section 4)
$d_{2x}$	-5.0	-5.2
$d_{2y}$	-12.5	-12.0
$d_{3x}$	-5.5	-5.2
$d_{3y}$	-11.0	-10.3

The three cable segments remained in tension throughout the experiment, and hence modelling them as solid pin-jointed bars (see Fig. 3c) is acceptable. In the obvious assumption that this problem can be treated as two-dimensional, the relevant matrix/vector dimensions are  $(2j-c) = (2 \times 4 - 4) = 4$  and  $b = 3$ . The system of equilibrium equations (1) for this assembly is

$$\begin{bmatrix} 0.8944 & -1 & 0 \\ 0.4472 & 0 & 0 \\ 0 & 1 & -0.8944 \\ 0 & 0 & 0.4472 \end{bmatrix} \begin{bmatrix} t_1 \\ t_2 \\ t_3 \end{bmatrix} = \begin{bmatrix} l_{2x} \\ l_{2y} \\ l_{3x} \\ l_{3y} \end{bmatrix}$$

First, we want to find the rank  $r$  of  $A$ ,  $s = b - r$  states of self-stress, and  $m = (2j - c - r)$  mechanisms, as well as the tensions  $t_0$  due to  $l_0$ . We consider the adjoint matrix

$$A|I|l_0 = \left[ \begin{array}{ccc|ccc|c} 0.8944 & -1 & 0 & 1 & 0 & 0 & 0 & 0 \\ 0.4472 & 0 & 0 & 0 & 1 & 0 & 0 & W \\ 0 & 1 & -0.8944 & 0 & 0 & 1 & 0 & 0 \\ 0 & 0 & 0.4472 & 0 & 0 & 0 & 1 & W \end{array} \right]$$

and we transform  $A$  into  $\tilde{A}$  by row operations

$$\tilde{A}|\tilde{I}|l_0 = \left[ \begin{array}{ccc|ccc|c} 1 & 0 & 0 & 1.118 & 0 & 1.118 & 2.236 & 2.236W \\ 0 & 1 & 0 & 0 & 0 & 1 & 2 & 2W \\ 0 & 0 & 1 & 0 & 0 & 0 & 2.236 & 2.236W \\ 0 & 0 & 0 & -0.5 & 1 & -0.5 & -1 & 0 \end{array} \right]$$

From this matrix we can extract the following information :

- the rank of  $A$  is  $r = 3$ , since three pivots have been found ;
- there are no states of self-stress, and hence  $A^r = A$ , since each column of  $\tilde{A}$  contains a pivot ;
- there is only one inextensional mechanism, which corresponds to the row of  $\tilde{A}$  without a pivot, and is found in the last row of  $\tilde{I}$ :  $d^1 = [-0.5 \ 1 \ -0.5 \ -1]^T$ . Hence we conclude that this assembly is of type II ;
- the load  $l_0$  lies in the Column space of  $A$ , since the last entry of  $\tilde{l}_0$  (corresponding to the row of  $\tilde{A}$  without a pivot) vanishes ;
- the tensions  $t_0$ , given by the remaining entries of  $\tilde{l}_0$ , are  $t_0 = [2.236W \ 2W \ 2.236W]^T$ . This result can be verified by elementary statics.

The nodal displacements caused by the elongations  $\delta e = [-10 \ 0 \ 0]^T$  imposed during the experiment, and certainly compatible since all elongation sets are compatible for a type II assembly, have to satisfy the system (17)

$$\begin{bmatrix} 0.8944 & 0.4472 & 0 & 0 \\ -1 & 0 & 1 & 0 \\ 0 & 0 & -0.8944 & 0.4472 \end{bmatrix} \begin{bmatrix} d_{2x} \\ d_{2y} \\ d_{3x} \\ d_{3y} \end{bmatrix} = \begin{bmatrix} -10 \\ 0 \\ 0 \end{bmatrix}$$

note that in this case  $\mathbf{B}' = \mathbf{A}^T$  and  $\delta \mathbf{e}' = \delta \mathbf{e}$ . To find the general solution of this system, we transform the matrix  $\mathbf{B}' | \delta \mathbf{e}'$  by row operations into

$$\tilde{\mathbf{B}}' | \delta \tilde{\mathbf{e}}' = \left[ \begin{array}{cccc|c} 1 & 0 & 0 & -0.5 & 0 \\ 0 & 1 & 0 & 1 & -22.36 \\ 0 & 0 & 1 & -0.5 & 0 \end{array} \right],$$

from which, by the technique already used in Section 2, we express the solution (18) as

$$\mathbf{d} = \begin{bmatrix} 0 \\ -22.36 \\ 0 \\ 0 \end{bmatrix} + \begin{bmatrix} -0.5 \\ 1 \\ -0.5 \\ -1 \end{bmatrix} \boldsymbol{\gamma}. \tag{19}$$

It is clear from the experiment that the displacement  $\mathbf{d}$  is uniquely defined, and therefore an additional condition on  $\mathbf{d}$  must exist, by which the one component of  $\boldsymbol{\gamma}$  can be fixed.

One might guess that, because the deformation under investigation is of an extensional type, perhaps  $\mathbf{d}$  should be orthogonal to the inextensional mechanism  $\mathbf{d}^1$ . In a more general case, this condition would yield  $m$  independent equations, which is precisely the number of components of  $\boldsymbol{\gamma}$  (however, on reflection, no sound mechanical argument seems to support this conjecture). Imposing this orthogonality condition on eqn (19), we obtain the equation

$$\left( \begin{bmatrix} 0 \\ -22.36 \\ 0 \\ 0 \end{bmatrix} + \begin{bmatrix} -0.5 \\ 1 \\ -0.5 \\ -1 \end{bmatrix} \boldsymbol{\gamma} \right)^T \cdot \begin{bmatrix} -0.5 \\ 1 \\ -0.5 \\ -1 \end{bmatrix} = 0, \tag{20}$$

from which  $\boldsymbol{\gamma} = [8.94]$  and hence  $\mathbf{d} = [-4.5 \quad -13.4 \quad -4.5 \quad -8.9]^T$  (mm), which is clearly in poor agreement with the measured values, shown in Table 2.

Rather surprisingly, if we compute from eqn (15) the vector of geometric loads associated with  $\mathbf{d}^1$

$$0.00625W[-1 \quad 6 \quad -1 \quad -6]^T,$$

and replace the inextensional mechanism on the l.h.s. of eqn (20) with this vector, we obtain

$$\boldsymbol{\gamma} = [10.32] \quad \text{and} \quad \mathbf{d} = [-5.2 \quad -12.0 \quad -5.2 \quad -10.3]^T \text{ (mm)}.$$

Having made allowance for the experimental error of  $\pm 0.5$  mm, these values are very accurate indeed.

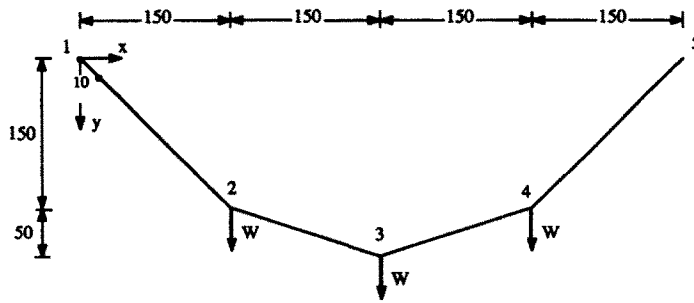

Fig. 4. Alternative experimental layout discussed in Section 4. All dimensions are in mm. The displacements which were measured after the r.h.s. cable had been shortened by 10 mm are given in Table 3.

The second experiment (Fig. 4) was conceptually similar to the first, but on an assembly which has two independent inextensional mechanisms. Therefore, to identify  $\mathbf{d}$  uniquely, we have to impose two conditions on  $\mathbf{y}$ . Extending the approach successfully adopted for the first experiment, we have imposed an orthogonality condition between  $\mathbf{d}$  and *all* vectors of geometric loads. The results shown in Table 3, which support our conjecture, have been obtained by solving a system of two equations in the unknowns  $\mathbf{y}$ .

It can be shown that the *orthogonality between extensional displacements and geometric loads* constitutes a general property of prestressed mechanisms; the proof, based on virtual work, is as follows. First, we consider the assembly in its initial configuration. As a force system, in equilibrium, we consider  $\mathbf{l}_0$  and  $\mathbf{t}_0$ ; as a displacement system we consider a general set of extensional displacements  $\mathbf{d}^{(i)}$  and the elongations  $\delta e$  which are compatible with them. The equation of virtual work is

$$\mathbf{l}_0^T \mathbf{d}^{(i)} = \mathbf{t}_0^T \delta e. \tag{21}$$

Secondly, we consider the assembly in a modified configuration which is obtained by imposing a small inextensional displacement  $\mathbf{D}\boldsymbol{\beta}$ ; the vector  $\boldsymbol{\beta}$  can have arbitrary, small values. As a force system we consider  $\mathbf{l}_0 + \mathbf{G}\boldsymbol{\beta}$  and  $\mathbf{t}_0$  which, by definition of geometric loads, are in equilibrium in the configuration considered; as a displacement system we consider the same  $\mathbf{d}^{(i)}$  and  $\delta e$  as above—they are still compatible because the change of configuration has been small. In this case the equation of virtual work is

$$(\mathbf{l}_0 + \mathbf{G}\boldsymbol{\beta})^T \mathbf{d}^{(i)} = \mathbf{t}_0^T \delta e. \tag{22}$$

Subtracting eqn (21) from eqn (22), we obtain

Table 3. Comparison of measured and computed components of nodal displacement (mm) for the cable shown in Fig. 4

Displacement components	Experiment	Computed
$d_{2x}$	-5.5	-5.4
$d_{2y}$	-8.5	-8.7
$d_{3x}$	-5.5	-5.5
$d_{3y}$	-8.0	-8.2
$d_{4x}$	-3.5	-4.2
$d_{4y}$	-4.0	-4.2

The computed values have been obtained solving an ordinary system of four compatibility equations, and imposing two additional conditions of orthogonality to the vectors of geometric loads associated with the two inextensional mechanisms.

$$\beta^T \mathbf{G}^T \mathbf{d}^{(i)} = 0$$

and, given that  $\beta$  can take any values, the above scalar condition is equivalent to the  $m$  conditions

$$\mathbf{G}^T \mathbf{d}^{(i)} = \mathbf{0}, \quad (23)$$

which is precisely what we set out to prove. Note that the above argument demonstrates that the orthogonality between extensional displacements and geometric loads originates from an equilibrium condition.

In conclusion, the evaluation of the components of nodal displacements  $\mathbf{d}^{(i)}$  caused by the compatible elongations  $\delta \mathbf{e}$  requires that the system of compatibility equation (17) be solved subject to eqn (23). These two sets of equations can be combined into

$$\begin{bmatrix} \mathbf{B}' \\ \mathbf{G}^T \end{bmatrix} \mathbf{d}^{(i)} = \begin{bmatrix} \delta \mathbf{e}^r \\ \mathbf{0} \end{bmatrix} \quad (24)$$

which is a system of  $(3j-c)$  linear equations and  $(3j-c)$  unknowns. It is remarkable that the square coefficient matrix

$$\mathbf{B}' = \begin{bmatrix} \mathbf{B}' \\ \mathbf{G}^T \end{bmatrix}$$

is the transpose of the matrix  $\mathbf{A}'$  in eqn (16). Thus, the well-known static-kinematic duality  $\mathbf{B} = \mathbf{A}'^T$  carries on to the present "mixed" formulation. It is noteworthy that:

- the system (24) admits a unique solution if the prestress  $\mathbf{t}_0$  stiffens all  $m$  inextensional mechanisms;
- the extensional displacement  $\mathbf{d}^{(i)}$  due to a set of compatible elongations  $\delta \mathbf{e}$  may change if the prestressing tensions  $\mathbf{t}_0$ , and hence the geometric loads  $\mathbf{G}$ , are altered;
- the system (23) is satisfied by any displacement  $\mathbf{d}^{(i)}$  if the assembly is *not prestressed*.

##### 5. NON-LINEAR RESPONSE IN MODE (ii)

The essentially linear analysis described in Sections 3 and 4 has been tested extensively by Pellegrino (1986), and found to be remarkably accurate for type II assemblies. However, it has been found that type IV assemblies loaded in mode (ii) undergo significant increases of prestress, and hence deform less than predicted by our linear analysis. This is because only an infinitesimal magnitude of the computed mechanisms is truly inextensional: as the load on the assembly is increased, each bar is required to alter its length a little, and hence the assembly tightens up. This non-linear effect, unaccounted for by the foregoing analysis, is best introduced as a final correction of the results obtained from the linear theory. The correction is significant in type IV assemblies, but becomes practically negligible in type II assemblies, where using slightly inaccurate displacement modes remains confined to the computation of nodal displacements, with little effect on the bar tensions.

For the sake of simplicity, we refer to an *assembly with arbitrary  $m > 0$  but  $s = 1$* , thus the matrix  $\mathbf{SS}$  reduces to the column vector  $\mathbf{ss}$ ; furthermore, we assume that the assembly is self-stressed, hence the initial tensions  $\mathbf{t}_0$  are in equilibrium with  $\mathbf{l}_0 = \mathbf{0}$ .

We apply on the assembly a purely inextensional load  $\delta \mathbf{l} = \delta \mathbf{l}^{(ii)}$  and, assuming that the prestress level does not change, compute its response using the linear theory. For the load condition chosen, the analysis is particularly simple, we solve the system (12) for the participation coefficients  $\beta$  and [from eqn (11)] the nodal displacements are  $\mathbf{d} = \mathbf{d}^{(ii)} = \mathbf{D} \beta$ . For each bar, we compute the difference between length in the final configuration and length in the initial configuration, each obtained by Pythagoras' theorem, and store these undesired

elongations in a vector  $\mathbf{e}^c$ . These elongations occur because the path described in  $(3j-c)$ -dimensional space by the displacement vector  $\mathbf{d}$  when  $\delta\mathbf{l}$  is applied, although initially tangent to the vector  $\mathbf{d}^{(ii)}$ , diverges from it as the load on the assembly is increased. To eliminate these undesired elongations, we plan to subject the assembly to the opposite set of elongations  $-\mathbf{e}^c$ .

The compatible part of  $-\mathbf{e}^c$ , given by

$$-\mathbf{e}^c + \mathbf{F} \mathbf{s} \mathbf{s} \alpha, \quad \text{with } \alpha = \frac{\mathbf{s} \mathbf{s}^T \mathbf{e}^c}{\mathbf{s} \mathbf{s}^T \mathbf{F} \mathbf{s} \mathbf{s}} \tag{25}$$

[see eqns (5) and (7)], causes a set of corrective displacements  $\mathbf{d}^c$ , which we can calculate from eqn (24). The incompatible part of  $-\mathbf{e}^c$  causes the self-stress increase  $\mathbf{s} \mathbf{s} \alpha$  (note that, in the present context,  $\alpha$  is a scalar, since  $s = 1$ ). Thus, the nodal displacements would become  $\mathbf{d}^{(ii)} + \mathbf{d}^c$  and the bar tensions  $\mathbf{t}_0 + \mathbf{s} \mathbf{s} \alpha$ ; however, the assembly would not be in equilibrium in this displaced configuration, because the geometric loads used for the analysis were based on  $\mathbf{t}_0$  only.

To account for the increase of stress level in an approximate way, we consider a reduced inextensional displacement vector  $\varepsilon \mathbf{d}^{(ii)}$ , with  $0 < \varepsilon < 1$ ; the elongations associated with it are reduced to  $\varepsilon^2 \mathbf{e}^c$ , and hence the corrective displacements are  $\varepsilon^2 \mathbf{d}^c$ . The stress level increase associated with this reduced displacement vector is  $\varepsilon^2 \mathbf{s} \mathbf{s} \alpha$ .

We shall use virtual work to find an equilibrium equation in  $\varepsilon$ . With the assembly in the configuration defined by the displacement vector

$$\varepsilon \mathbf{d}^{(ii)} + \varepsilon^2 \mathbf{d}^c, \tag{26}$$

we consider as a force system the applied load  $\delta\mathbf{l}^{(ii)}$  and the bar tensions  $\mathbf{t}_0 + \varepsilon^2 \mathbf{s} \mathbf{s} \alpha$ , in equilibrium. As a displacement system we consider the nodal displacements  $(\mathbf{d}^{(ii)} + 2\varepsilon \mathbf{d}^c) d\varepsilon$ , obtained by differentiation of (26), and the bar elongations  $2\varepsilon \mathbf{e}^c d\varepsilon$  associated with them. Equating external work to internal work and dividing by  $d\varepsilon$  we obtain

$$\delta\mathbf{l}^{(ii)T} (\mathbf{d}^{(ii)} + 2\varepsilon \mathbf{d}^c) = (\mathbf{t}_0 + \varepsilon^2 \mathbf{s} \mathbf{s} \alpha)^T 2\varepsilon \mathbf{e}^c.$$

Recalling that a compatible elongation is orthogonal to any state of self-stress (Fig. 1), it can easily be verified that the incompatible part of  $\mathbf{e}^c$  does not contribute to the dot product on the r.h.s. Therefore we can write the above expression as

$$2 \mathbf{s} \mathbf{s}^T \mathbf{F} \mathbf{s} \mathbf{s} \alpha^2 \varepsilon^3 + 2(\mathbf{t}_0^T \mathbf{F} \mathbf{s} \mathbf{s} \alpha - \delta\mathbf{l}^{(ii)T} \mathbf{d}^c) \varepsilon - \delta\mathbf{l}^{(ii)T} \mathbf{d}^{(ii)} = 0. \tag{27}$$

It can be shown by a simple energy argument, for an assembly with bar tensions which remain constant at  $\mathbf{t}_0$ , that  $\delta\mathbf{l}^{(ii)T} (\frac{1}{2} \mathbf{d}^{(ii)} - \mathbf{d}^c) = \mathbf{t}_0^T \mathbf{F} \mathbf{s} \mathbf{s} \alpha$ ; hence, dividing eqn (27) by  $\delta\mathbf{l}^{(ii)T} \mathbf{d}^{(ii)}$

$$\frac{2 \mathbf{s} \mathbf{s}^T \mathbf{F} \mathbf{s} \mathbf{s} \alpha^2}{\delta\mathbf{l}^{(ii)T} \mathbf{d}^{(ii)}} \varepsilon^3 + \varepsilon - 1 = 0, \tag{28}$$

from which  $\varepsilon$  can be computed. The main stages of this non-linear correction are highlighted, for a simple example, in Fig. 5.

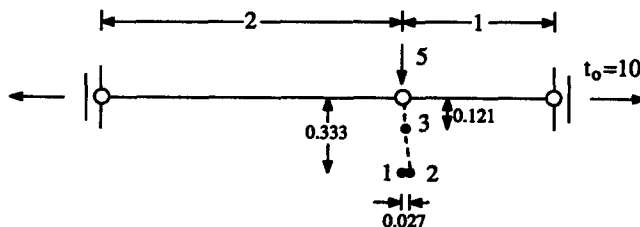

Fig. 5. Non-linear correction for a simple two-bar assembly. The initial, linear analysis of this problem yields a purely vertical displacement vector (point 1). The corrective displacement  $\mathbf{d}^c$  is purely horizontal (point 2); the prestress level corresponding to this deflection is 146 units, instead of the initial 10. The cubic equation in  $\varepsilon$  has the solution  $\varepsilon = 0.363$ , which corresponds to a prestress level of 27.9 units. The "corrected" deflection is shown by point 3.

For an assembly with  $s$  independent states of self-stress,  $\varepsilon$  would be replaced by an  $s$ -dimensional vector, and we would end with a system of  $s$  cubic equations broadly similar to eqn (28). The accuracy of this method is being checked.

Finally, the reader should be reminded that the non-linear correction introduced above has the following two limitations. Firstly, it assumes that—although large enough to cause significant changes of bar tensions—the configuration change must be sufficiently small to justify the use of joint equilibrium equations which refer to the original configuration. Secondly, it assumes that the reduction in displacements caused by the self-stress increase can be dealt with by one parameter only, if  $s = 1$ , regardless of the number of joints. These assumptions appear to be entirely acceptable in many problems of practical interest, as discussed in the next section.

## 6. AN EXPERIMENT

A series of careful tests on cable structures has been carried out to validate the present approach. Here only a representative experiment will be discussed, but a fuller report is available in Pellegrino (1986). Figure 6a shows a sketch of a saddle-shaped cable net which

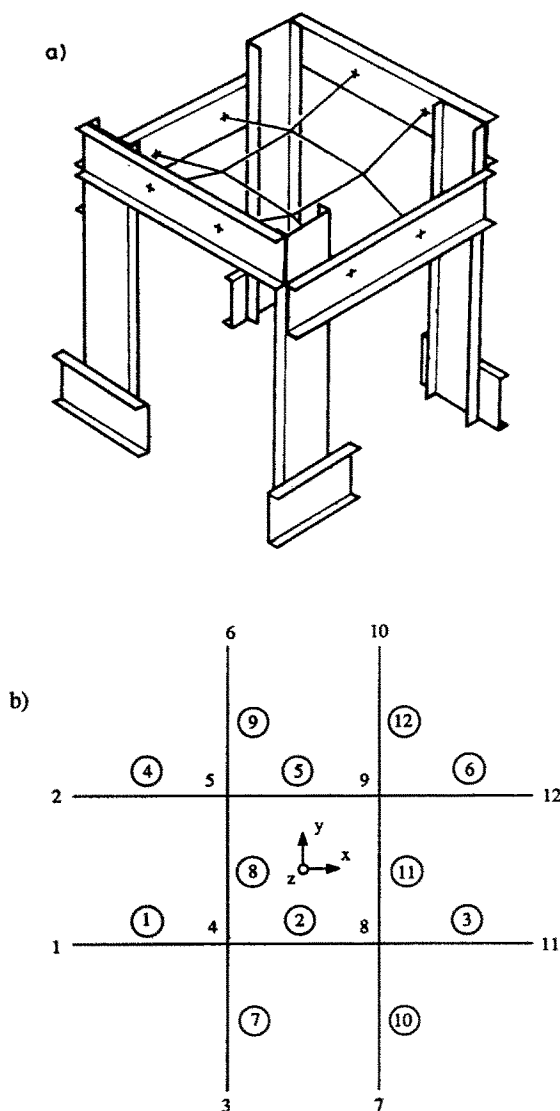

Fig. 6. (a) Sketch showing the cable net discussed in Section 6, with support frame. (b) Plan view showing node and bar numbering systems; the nodal coordinates are given in Table 4. The  $z$ -axis is upwards.



Table 4. Nodal coordinates (mm) of cable net shown in Fig. 6

Node	$x$	$y$	$z$
1	-961	-305	155
2	-961	305	155
3	-305	-961	-146
4	-305	-305	0
5	-305	305	0
6	-305	961	-146
7	305	-961	-146
8	305	-305	0
9	305	305	0
10	305	961	-146
11	961	-305	155
12	961	305	155

was tested in the Structures Laboratory of Cambridge University Engineering Department. The assembly consists of two parallel sagging wires (segments 1, 2, 3 and 4, 5, 6 of Fig. 6b) connected by adjustable tensioning devices to a steel supporting frame, and of two similar hogging wires at right angles to them. The measured coordinates of the joints are given in Table 4. The wires, of high tensile steel "piano wire" (27-gauge, i.e. 0.42 mm diameter), were connected by steel bolts in which holes at right angles had been drilled. Apart from some small irregularities in its shape, which had to be introduced for various practical reasons, this cable net is the simplest of a family which has been discussed by Calladine (1982) and Pellegrino and Calladine (1984).

Our analysis shows that a pin-jointed assembly with the geometry of Fig. 6,  $(3j-c) = 12$  and  $b = 12$ , has  $r = 11$  and hence it is both statically indeterminate, with  $s = 1$ , and kinematically indeterminate, with  $m = 1$ . Therefore this assembly is of type IV. Its state of self-stress is proportional to

$$[a b a a b a c d c c d c]^T,$$

where  $a = 1.027$ ,  $b = 1$ ,  $c = 1.088$  and  $d = 1.062$ ; its inextensional mechanism is proportional to

$$[e -f g -e -f -g e f -g -e f g]^T,$$

where  $e = 1.062$ ,  $f = 1$ , and  $g = 4.493$ . Once presented, this assembly has a set of geometric loads whose directions resemble the mechanism displacements, although they do not actually coincide with them.

In the test, the prestress was set at about 80 N. Two different load cases were investigated and, in each case, the load was applied in 10 increments of 5 N each. After each load increment, all bar tensions and all components of nodal displacement were measured.

The first load condition consisted of four equal vertical loads directed downwards, on nodes 4, 5, 8, 9, which involve only mode (i) response. Figure 7 shows some selected results from this test. Note that all plots are more or less linear, as indeed one would expect for a load condition which does not excite the non-linear stiffening effect discussed in Section 5. It can be seen from Fig. 7a that the horizontal square in the middle of the net translates downwards, and from Fig. 7b that the tension in the sagging wires (segments 1-6) increases, while the tension in the hogging wires (segments 7-12) decreases. Our theoretical analysis predicts that the hogging wires become slack at a load of about 41 N; this is confirmed by the experiment. The deflection/load plots (Fig. 7a) show that the assembly becomes softer at about this value of the load; this is due to the sudden transition from a cable net to an assembly of two independent (sagging) wires. A similar softening is detected in tests on beams supported by unilateral constraints, when the beam loses contact with a support.

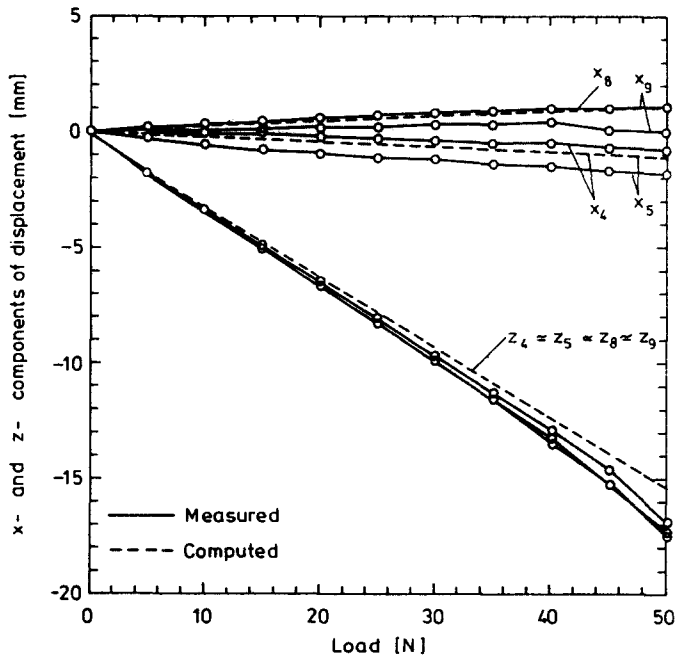

a)

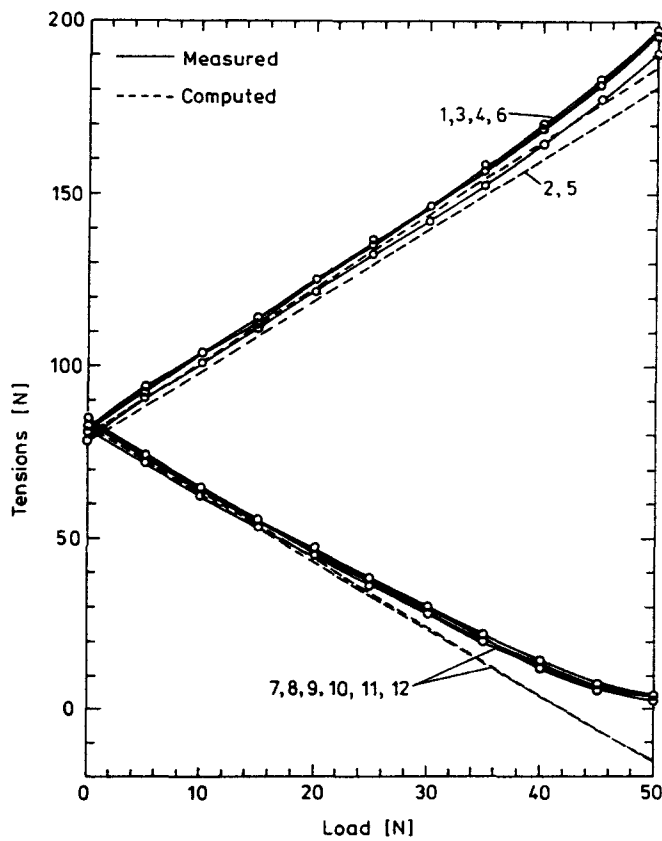

b)

Fig. 7. Plots of displacements (a) and wire tensions (b) vs applied load for the cable net of Fig. 6. The load condition consists of four equal downward forces. The variable "load" plotted is the value of only one of these forces. Note that the hogging cables become slack at a load of about 41 N. The technique used for measuring wire tensions (Pellegrino, 1986), although very reliable for values above 40–50 N, become less reliable at lower tensions.

We could, of course, repeat our analysis after removing the members which have gone slack.

The second load condition consisted of two equal downward loads acting on nodes 5 and 8. This load system excites both modes (i) and (ii), and hence involves some non-linear increase of the prestress level, as explained in Section 5. This effect can be seen clearly in Fig. 8; in particular, the tensions in the hogging wires decrease at low loading levels—due to mode (i) prevailing—but then remain approximately constant as the prestress increases.

In both tests, the agreement between experimental and predicted values, based on the theory developed in earlier sections, is good in spite of the simplifications introduced. It should be noted that the largest measured deflection (about 30 mm) is only 1.6% of the total span although the applied load more than doubles the initial tensions, confirming a remark, in the Introduction, that often a full non-linear analysis is not required.

## 7. DISCUSSION

The approach presented in this paper captures the main features of the response of prestressed mechanisms, thus providing some useful tools for anticipating the effects of design changes, spotting which load conditions are likely to be critical for some particular effect (e.g. to cause cable slackening), etc. Although the method is based on a small displacements theory, it has been shown that tensions and displacements can be predicted within a few percent of measured values. These small errors should certainly be acceptable for most applications, and certainly at the stage of a preliminary design, when several alternatives are being considered; a more conventional non-linear analysis may be carried out as a final check, if necessary.

Comparisons between a computer program based on the present approach, and a geometrically non-linear finite element program which uses a tangent stiffness matrix within an incremental procedure with corrective iterations (See, 1983), have shown that the finite element program is between two and five times slower, depending on the type and magnitude of the load condition.

An important issue in the design of prestressed mechanisms, which has not been addressed in this paper, is that of finding configurations which are suitable for prestressing. In some cases these initial configurations can be found by an *ad hoc* method, which is rather easy for the cable systems of Figs 3, 4 and 6. General techniques for the solution of the non-linear equations involved have been discussed in the literature [see e.g. Day (1965) and Barnes (1984)], but the present approach could be used in that context as well. Clearly, if the configuration changes are large, the matrices **A** and **B** need to be updated. So far, some encouraging results have been obtained for trusses which are “deployed” by gradually shortening one or two cables (Kwan and Pellegrino, 1989).

Finally, returning to the hypothesis (Section 3) that the prestressed mechanism should be in stable equilibrium in its initial configuration, it should be noted that the present method of analysis can easily be extended to assemblies which, due to insufficient kinematic constraints, have some rigid-body mechanisms. A general technique to separate out the rigid-body mechanisms from the internal mechanisms is available in Pellegrino and Caladine (1986). Clearly, zero geometric loads will be associated with these rigid-body displacements, and the corresponding vectors need not be assembled in the matrix **G**. Thus **A'** and **B'** are no longer square. However, the response to any load  $\delta l$  which is orthogonal to all rigid-body mechanisms can still be found from eqn (16), and the extensional displacements due to compatible elongations  $\delta e$  from eqn (24). Of course, rigid-body displacements of indeterminate magnitude will appear in the final answer.

## 8. SUMMARY OF CALCULATIONS

In summary, the method of analysis described in this paper consists of the following four steps.

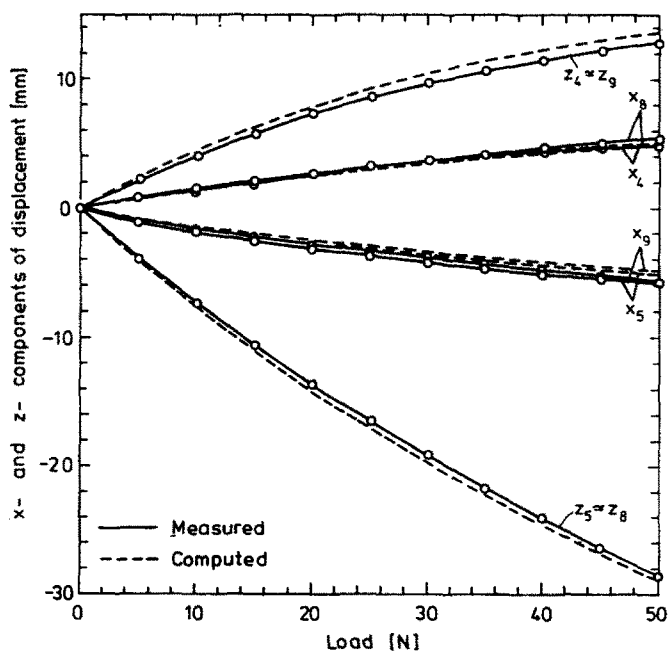

a)

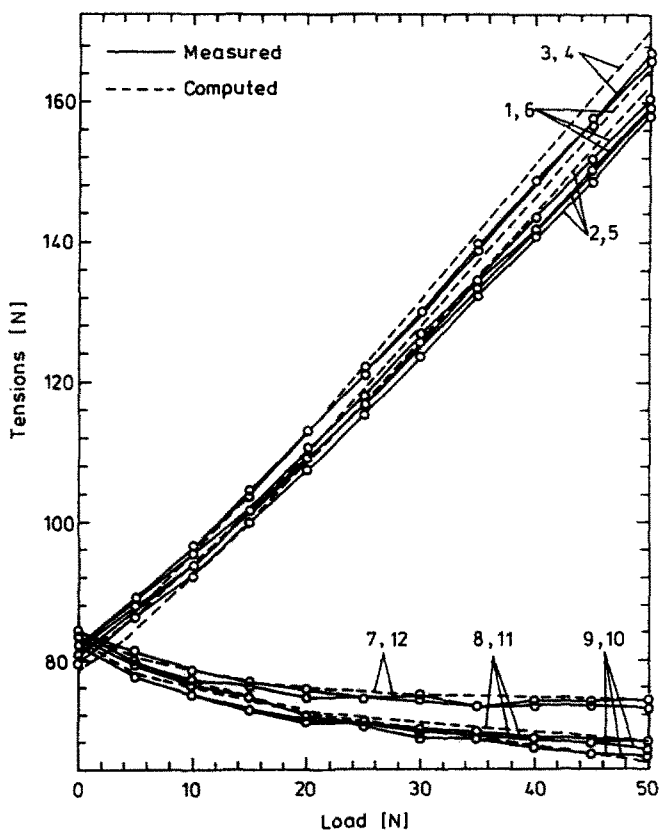

b)

Fig. 8. As Fig. 7, but for a load system consisting of equal downward forces on nodes 5 and 8, which are diagonally opposite.

## (i) Preliminary analysis of given assembly :

- computation of equilibrium matrix  $A$  ;
- transformation of  $A|I$  into  $\tilde{A}|\tilde{I}$  by row operations ;
- initialization of matrix  $D$ , which contains  $m$  independent inextensional mechanisms ;
- identification of  $s$  redundant bars and equilibrium matrix of reduced size  $A'$  ;
- initialization of matrix  $SS$ , which contains  $s$  independent states of self-stress.

(ii) Calculation of prestress, for given initial loads  $l_0$  and elongations  $e$  :

- solution of  $A't' = l_0$  (possible only if  $l_0$  lies in the Column space of  $A$ ) and initialization of vector  $t'$ , which contains the entries of  $t'$  interspersed with  $s$  zeros ;
- solution of  $SS^T F SS \alpha = -SS^T(e + F t')$ .

The corresponding bar forces are  $t_0 = t' + SS \alpha$ .

(iii) Linear response to additional loads  $\delta l$  and elongations  $\delta e$  :

- computation of  $m$  sets of geometric loads, for the current bar forces, stored in the matrix  $G$  ;
- solution of  $[A'|G][\delta t'/\beta] = \delta l$  and initialization of vector  $\delta t'$  ;
- solution of  $SS^T F SS \alpha = -SS^T(\delta e + F \delta t')$ , from which  $\delta t = \delta t' + SS \alpha$ .

The current bar forces are  $t = t_0 + \delta t$ . If they are significantly different from the bar forces used when computing  $G$ , the above three steps are repeated ; otherwise the analysis continues with

- computation of  $\delta e = \delta e + F \delta t$ , and solution of

$$[A'|G]^T d^{(i)} = \begin{bmatrix} \delta e' \\ 0 \end{bmatrix}.$$

The nodal displacements are  $d = d^{(i)} + D \beta$ .

(iv) Non-linear correction of (iii), for  $s > 0$  only ; see Section 5.

*Acknowledgements*—I am grateful to Mr D. M. Steer for the careful experimental work described in Section 6, and to Mr R. Denston for technical assistance. I thank Professor C. R. Calladine for his interest in this work and continuing advice.

## REFERENCES

- Argyris, J. H. (1964). *Recent Advances in Matrix Methods of Structural Analysis*. Pergamon Press, Oxford.
- Barnes, M. R. (1984). Form-finding, analysis and patterning of tension structures. In *Proc. Third Int. Conf. Space Structures, Guildford* (Edited by H. Nooshin), pp. 730–736. Elsevier Applied Science, London.
- Berry, M. W., Heath, M. T., Kaneko, I., Lawo, M., Plemmons, R. J. and Ward, R. J. (1985). An algorithm to compute a sparse basis of the nullspace. *Num. Math.* **47**, 483–504.
- Buchholdt, H. A. (1985). *An Introduction to Cable Roof Structures*. Cambridge University Press, Cambridge.
- Calladine, C. R. (1978). Buckminster Fuller's "Tensegrity" structures and Clark Maxwell's rules for the construction of stiff frames. *Int. J. Solids Struct.* **14**, 161–172.
- Calladine, C. R. (1982). Modal stiffnesses of a pretensioned cable net. *Int. J. Solids Struct.* **18**, 829–846.
- Calladine, C. R. and Pellegrino, S. (1990). First order infinitesimal mechanisms. *Int. J. Solids Struct.* (to appear).
- Day, A. S. (1965). An introduction to dynamic relaxation. *Engineer* **219**, 218–221.
- De Veubeke, F. (1973). The numerical analysis of structures. In *Proc. 13th ICTAM* (Edited by Becker and Mikhailov), pp. 20–28. Springer, Berlin.
- Filho, F. V. (1966). Orthogonalization of internal force and strain systems. In *Matrix Methods in Structural Mechanics*, Proc. Conf., pp. 66–80. Wright-Patterson Air Force Base, Ohio, AFFDL-TR-66-80.
- Fuller, R. B. (1975). *Synergetics*, 2nd Edn. Macmillan, New York.
- Gillis, P. P. and Gerstle, K. H. (1961). Analysis of structures by combining redundants. *J. Struct. Div., ASCE* **87**, 41–56.
- Golub, G. H. and Van Loan, C. F. (1983). *Matrix Computations*. North Oxford Academic, Oxford.
- Hanaor, A. (1987). Preliminary investigation of double-layer tensegrities. In *Proc. Int. Conf. Design Construction Non-Conventional Structures* (Edited by B. H. V. Topping), Part 2, pp. 35–42. Civil-Comp Press, Edinburgh.
- Kaneko, I., Lawo, M. and Thierauf, G. (1982). On computational procedures for the force method. *Int. J. Numer. Meth. Engng* **18**, 1469–1495.

- Kuznetsov, E. N. (1973). Problems in the statics of variable systems. *Izv. ANSSR* **8**, 108–112 (in Russian). English translation in *Russian Mechanics of Solids*, pp. 90–94. Allerton Press, New York.
- Kwan, A. and Pellegrino, S. (1989). A new deployable mast. *Proc. 12th Canadian Cong. Appl. Mech.* (Edited by M. A. Erki and J. Kirkhope), Carleton University, Ottawa, pp. 334–335.
- Livesley, R. K. (1975). *Matrix Methods of Structural Analysis*, 2nd Edn. Pergamon Press, Oxford.
- Mollmann, H. (1974). *Analysis of Hanging Roofs by Means of the Displacement Method*. Polyteknisk Forlag, Lyngby.
- Pellegrino, S. (1986). Mechanics of kinematically indeterminate structures. Ph.D. dissertation, University of Cambridge.
- Pellegrino, S. and Calladine, C. R. (1984). Two-step matrix analysis of prestressed cable nets. In *Proc. Third Int. Conf. Space Structures, Guildford* (Edited by H. Nooshin), pp. 744–749. Elsevier Applied Science, London.
- Pellegrino, S. and Calladine, C. R. (1986). Matrix analysis of statically and kinematically indeterminate frameworks. *Int. J. Solids Struct.* **22**, 409–428.
- Pestel, E. C. and Leckie, F. A. (1963). *Matrix Methods in Elastomechanics*. McGraw-Hill, New York.
- Przemieniecki, J. S. (1968). *Theory of Matrix Structural Analysis*. McGraw-Hill, New York.
- Robinson, J. (1966). *Structural Matrix Analysis for the Engineer*. John Wiley, New York.
- Robinson, J. and Haggemacher, G. W. (1970). Optimization of redundancy selection in the finite element force method. *AIAA Jnl* **8**, 1429–1433.
- See, T. (1983). Large displacement elastic buckling of space structures. Ph.D. dissertation, University of Cambridge.
- Strang, G. (1980). *Linear Algebra and Its Applications*, 2nd Edn. Academic Press, New York.